



NÁVRH MOBILIÁRU

ZADANIE

Design mobiliáru pre obchodnú sieť COOP Jednota —

- odpadkový kôš
- lavička
- stojan na bicykle

Podmienky —

- inovatívnosť, prémiovosť
- cenová relácia — materiál/cena — redukcia materiálu
- bez materiálovej skladby

TVAROSLOVIE

Tvaroslovie vychádza z loga spoločnosti.

Mobiliár je vytvorený za použitia minima prvkov, ktoré sa v tvarosloví opakujú.

Hlavný konštrukčný prvok predstavuje nerovnostanný profil, prepájaný s ocelovou skružou (atypické tvaroslovie)

Tvaroslovie má v zákazníkoch vyvolať emócie.

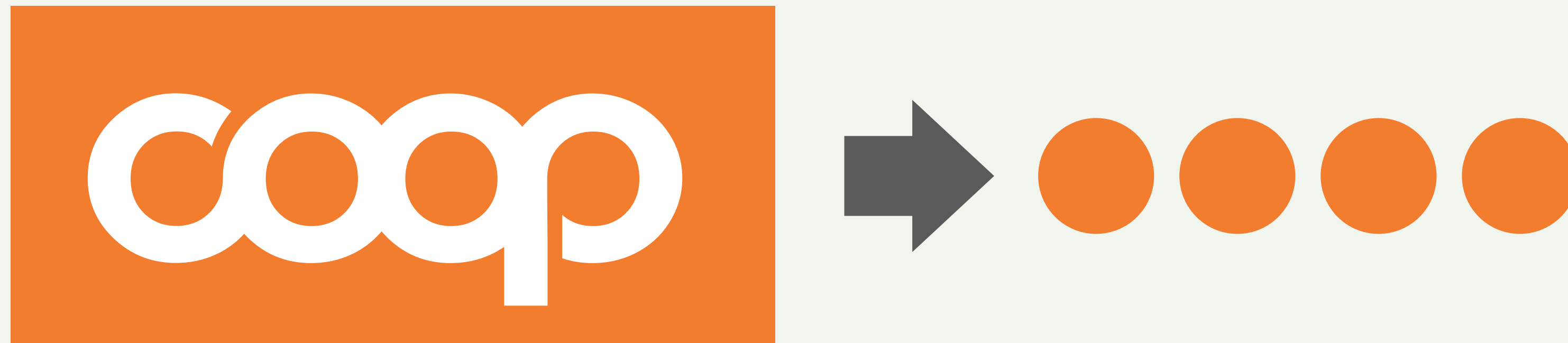

MATERIALOVÁ/TECHNICKÁ SKLADBA

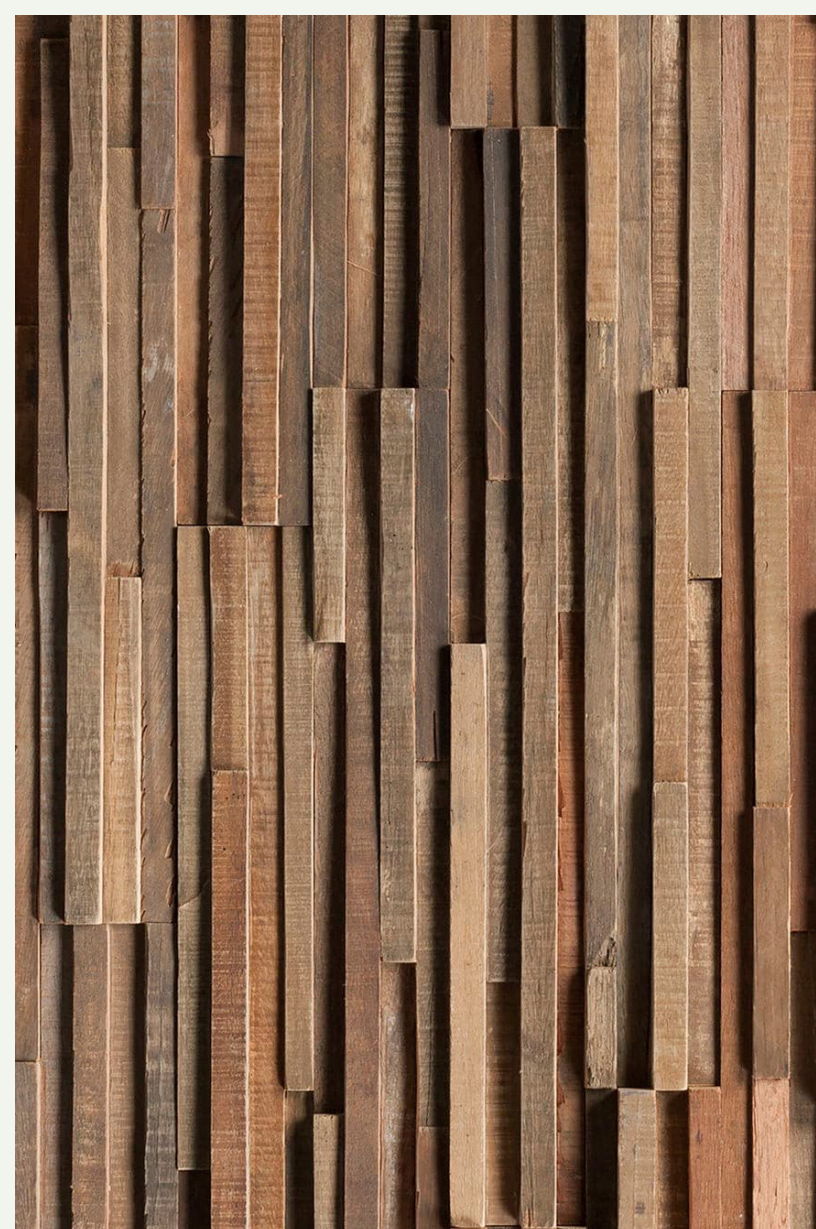

- drevo do exteriéru
(buk, teak, iroco, kurbaryl)

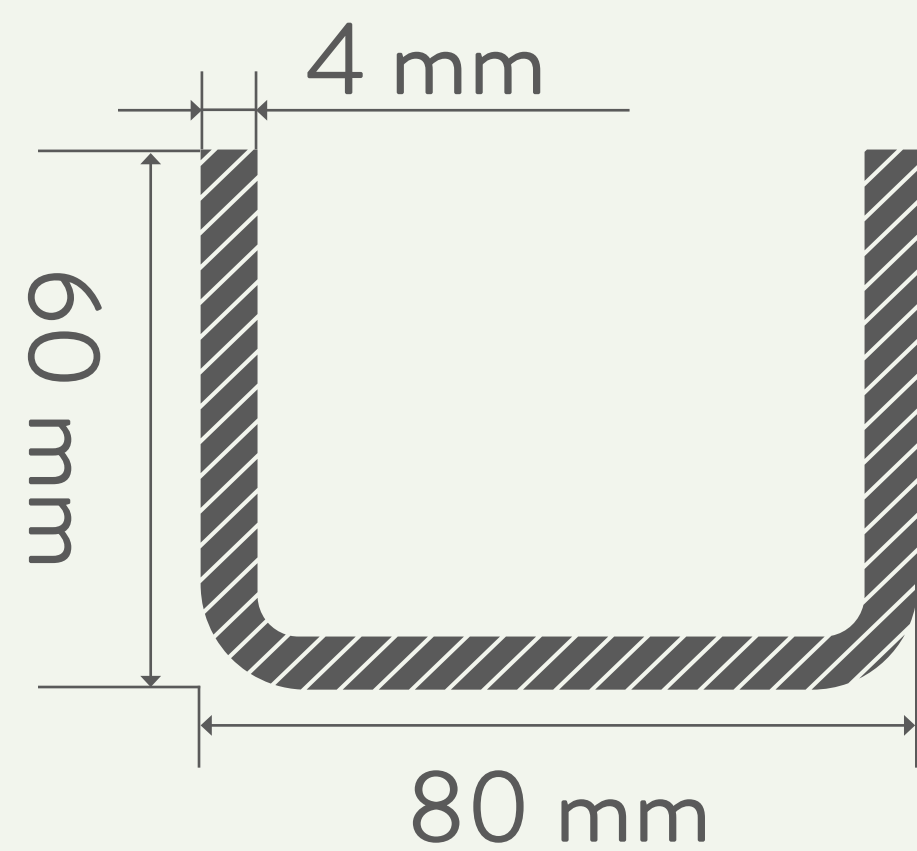

- tenkostenný nerovnostranný profil tvaru U
(akost' – S235JR)
- praškový vypalovaný lak (komaxit)
(povrchová úprava)

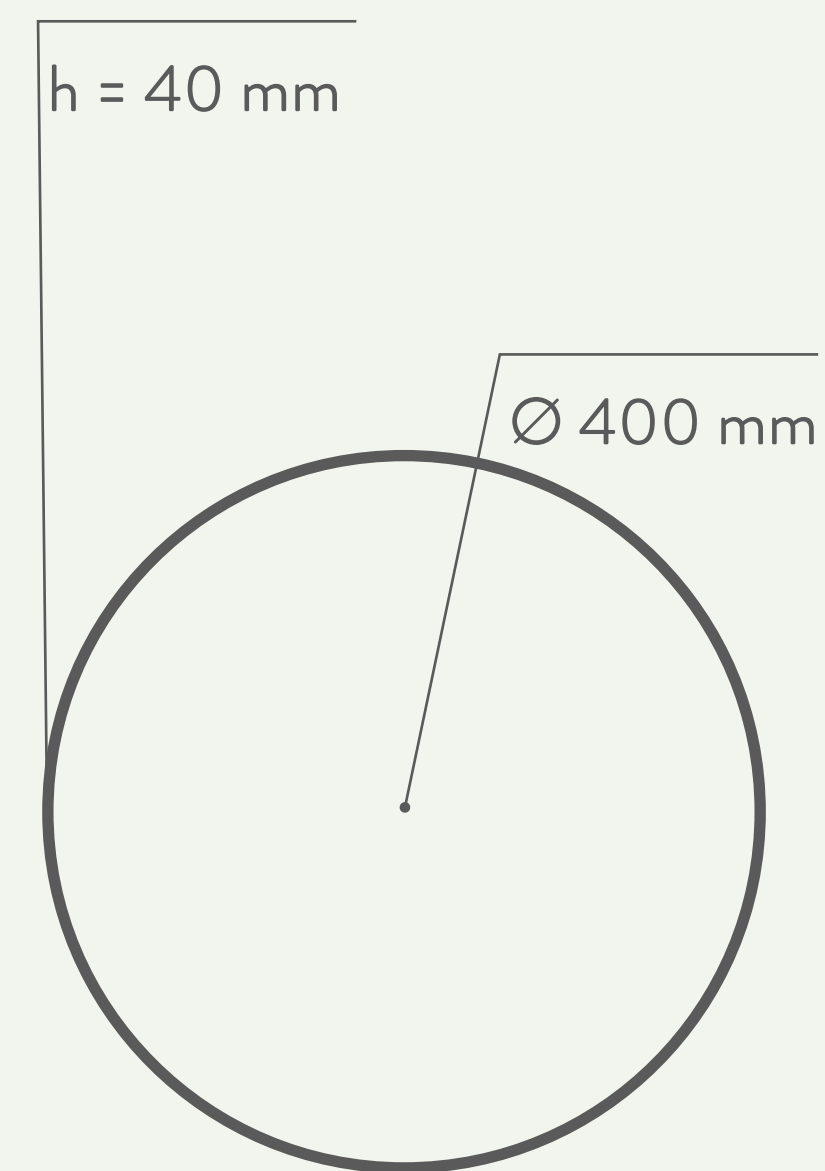
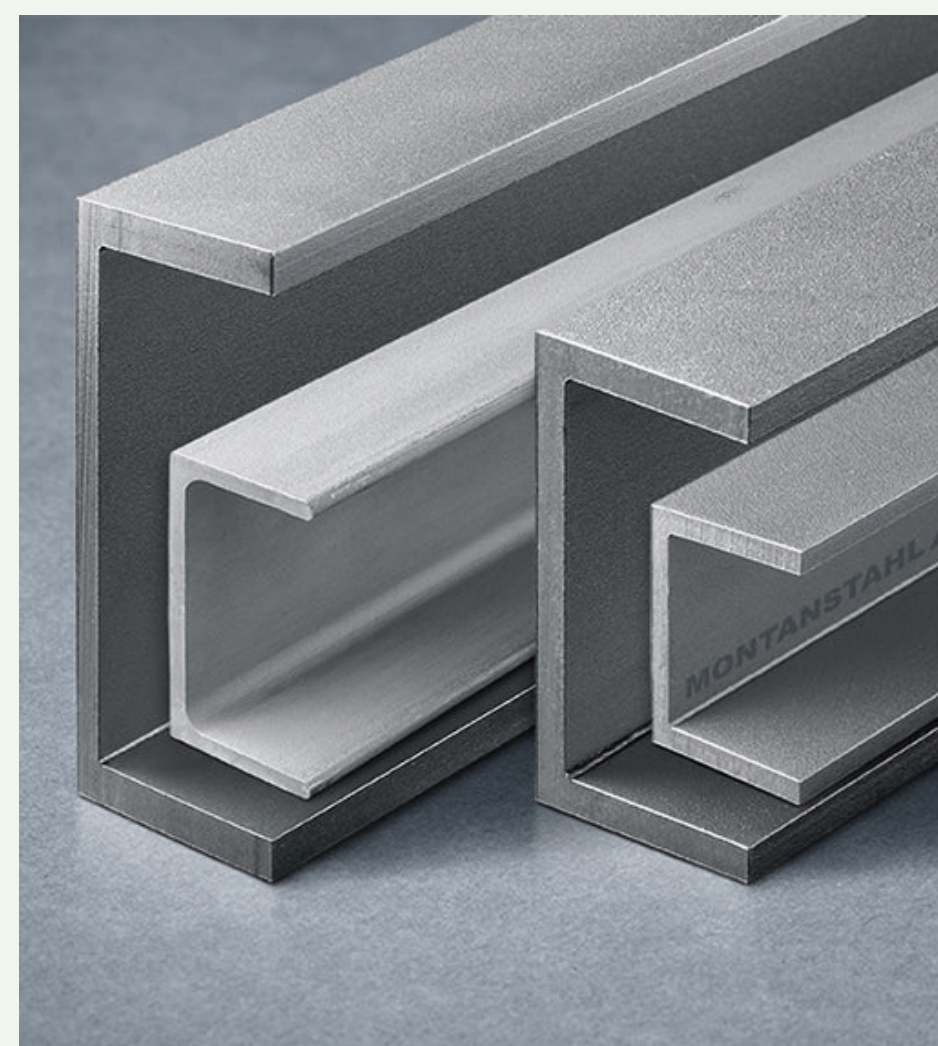

- ocel'ová skruž

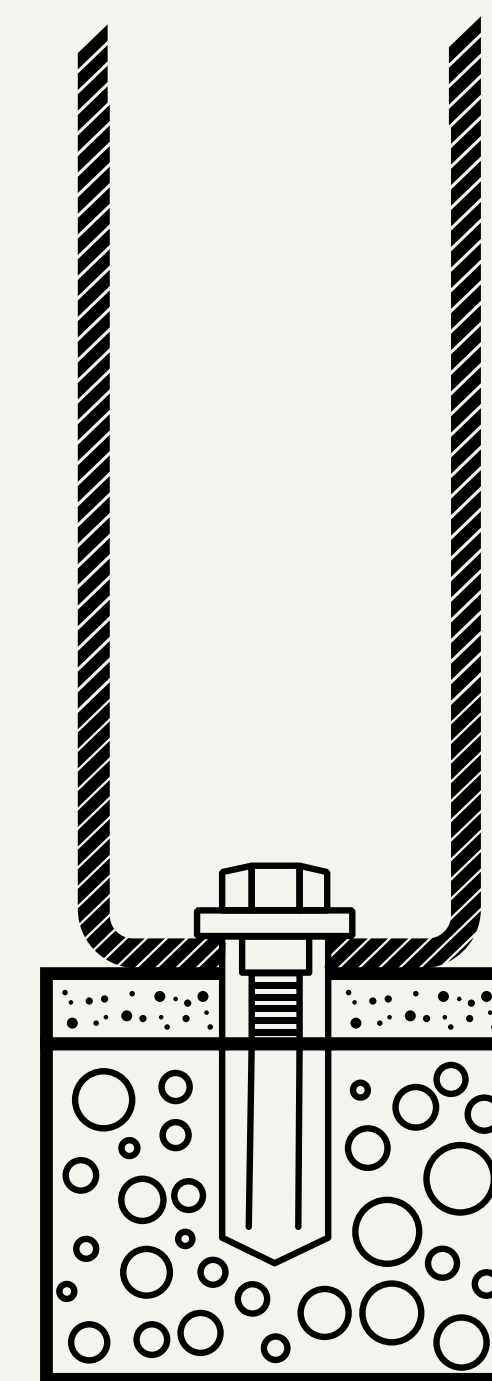

- chemická kotva

VIZUALIZÁCIA



LAVIČKA



- odsadenie medzi skružami
- vertikálne podpery umiestnené na stred osi bočných skruží



DETAIL



- vertikálne umiestnenie nôh
- podporný profil (základňa pre skrutky)

TECHNICKÉ ROZMERY

čelný pohľad:

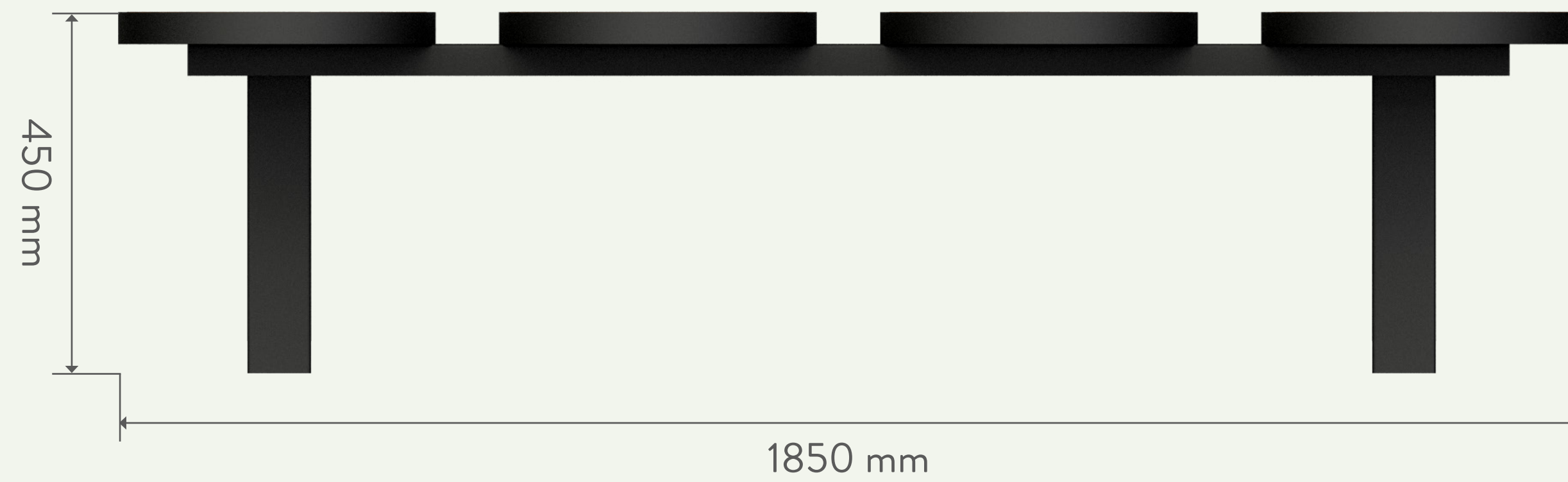

bočný pohľad:

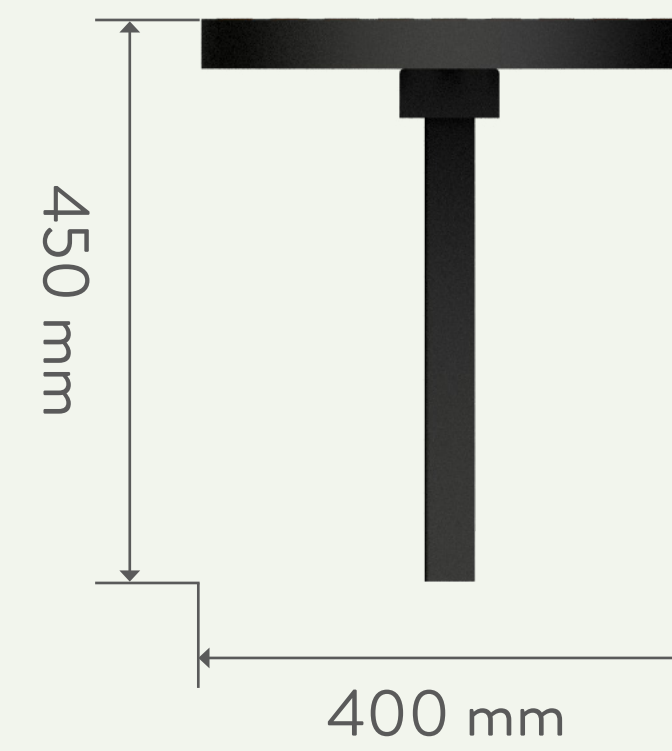

spodný pohľad na sedák:

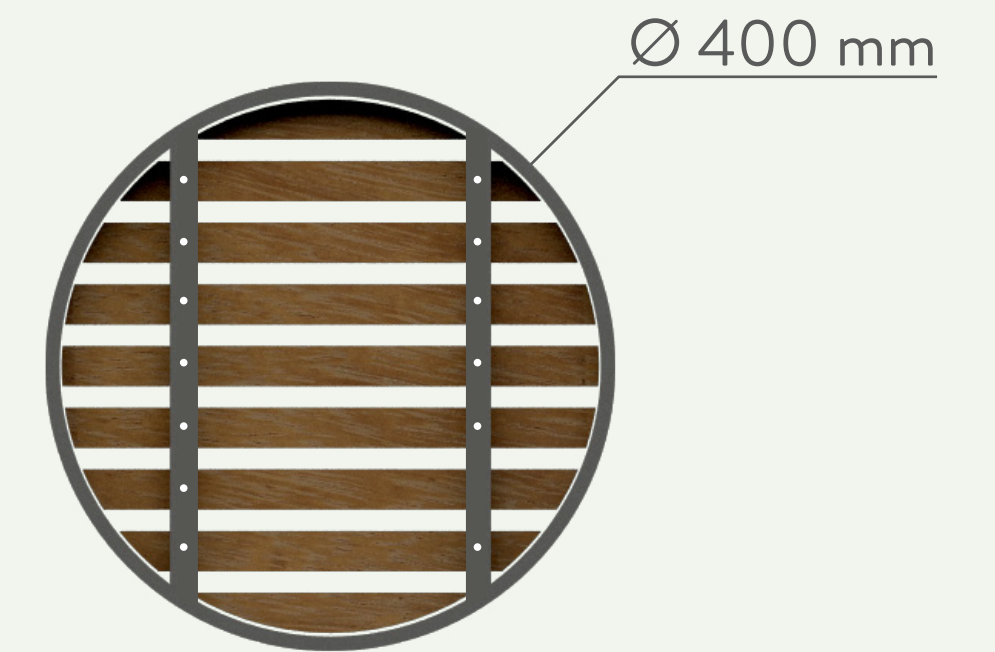

vrchný pohľad:



spodný pohľad:



LAVIČKA



LAVIČKA

- rozšírené varianty sedenia

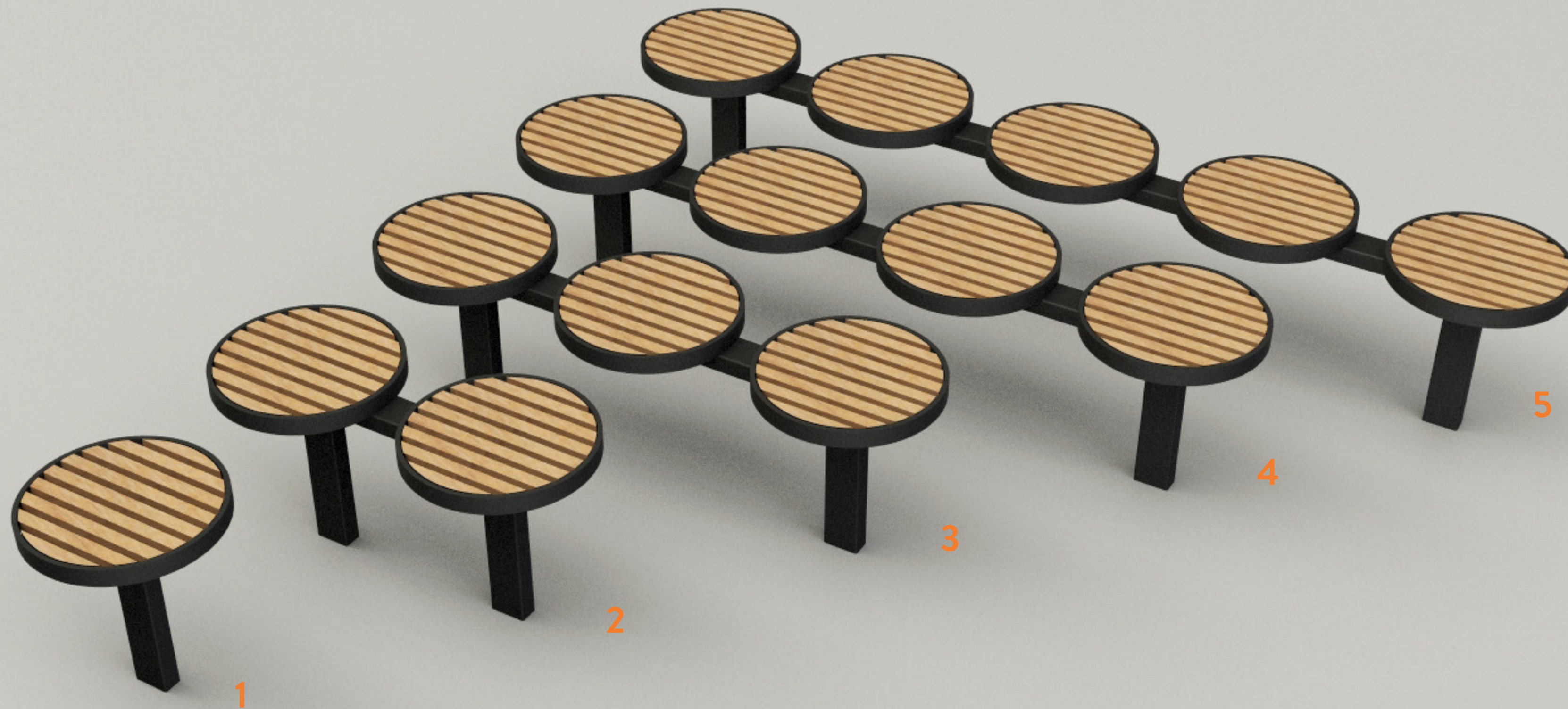

LAVIČKA

- preferované varianty sedenia

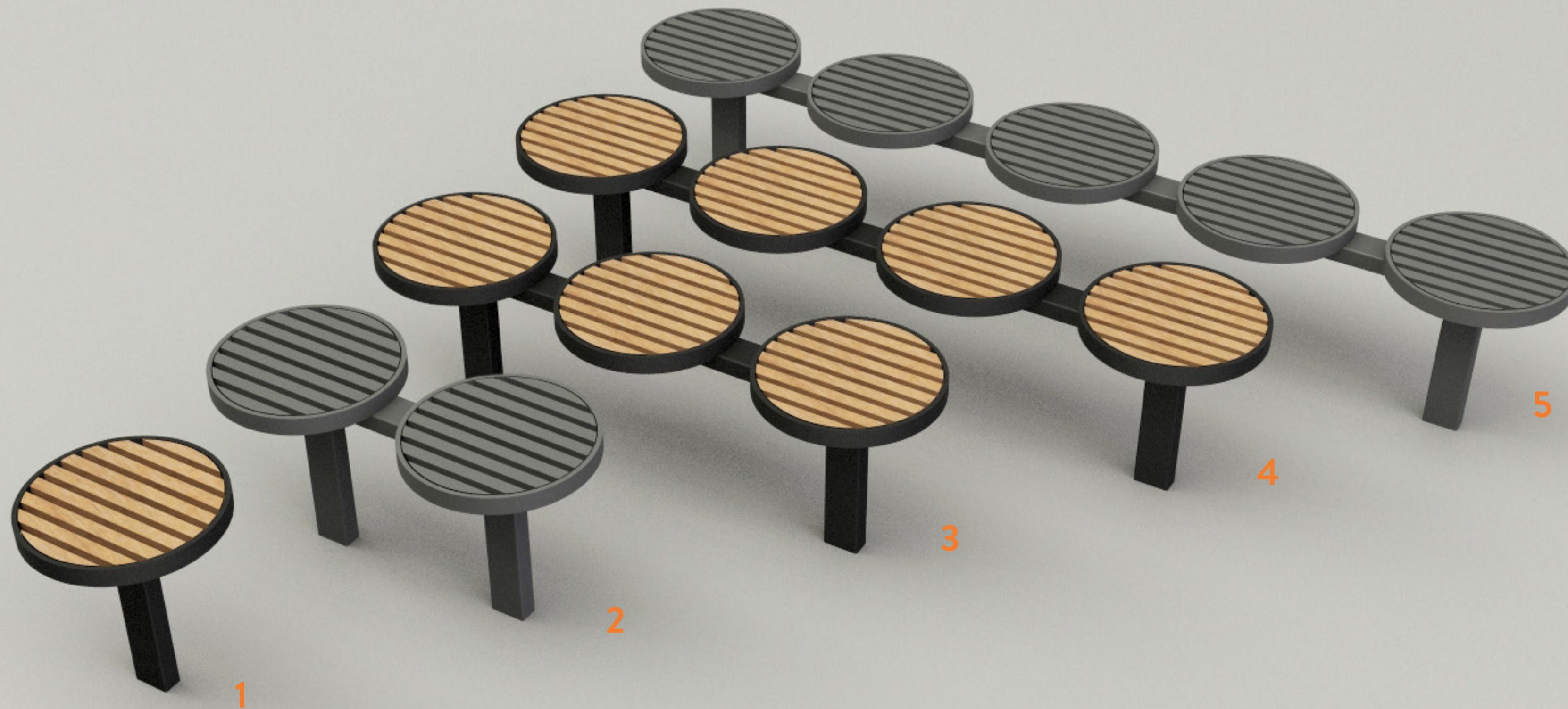

VIZUALIZÁCIA

COOP TERNO

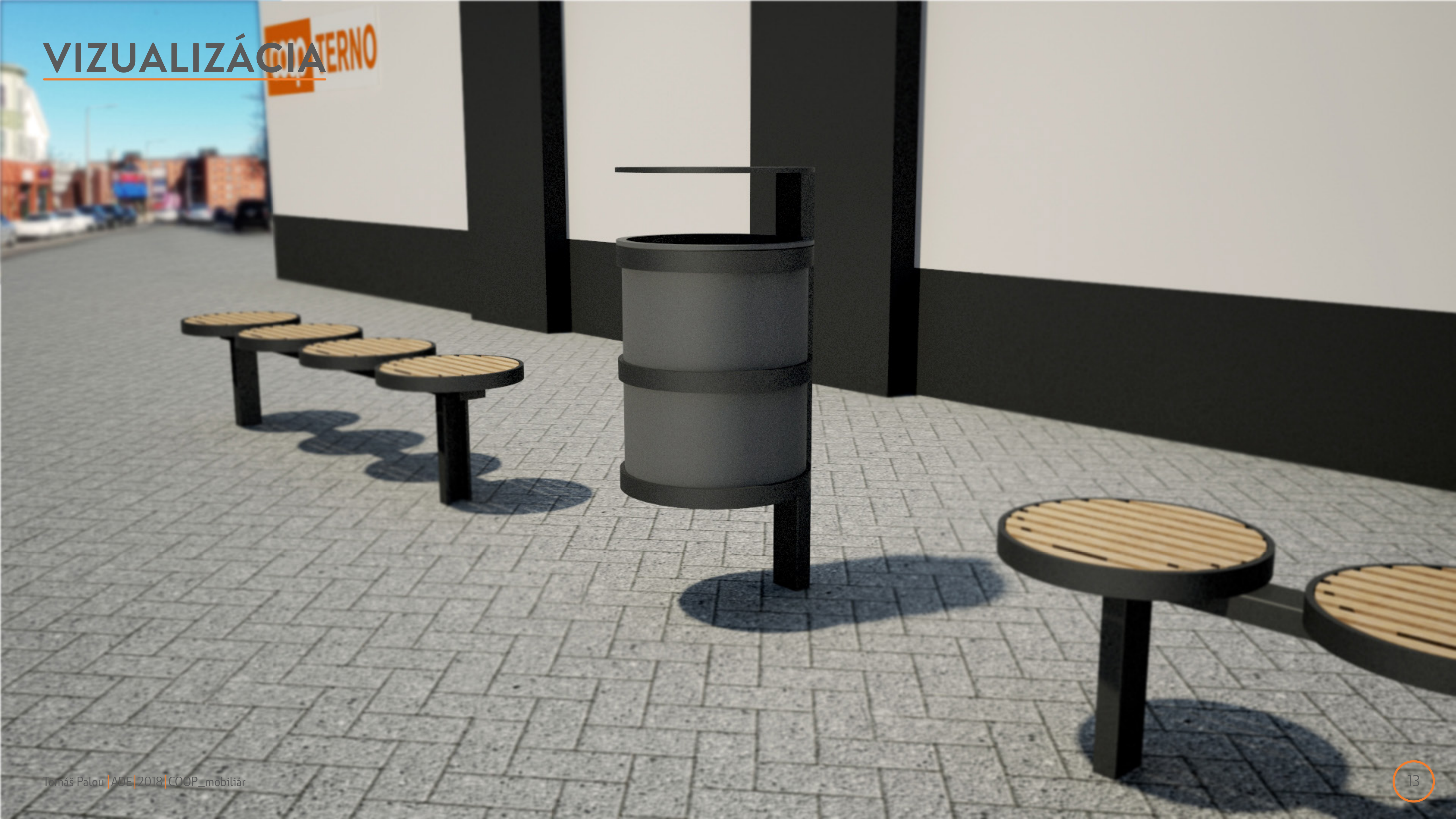

ODPADKOVÝ KÔŠ



- strieška má predstavovať štvrtú skruž

ODPADKOVÝ KÔŠ

- ukážka vytiahnutej nádoby na odpad
- objem 50 l

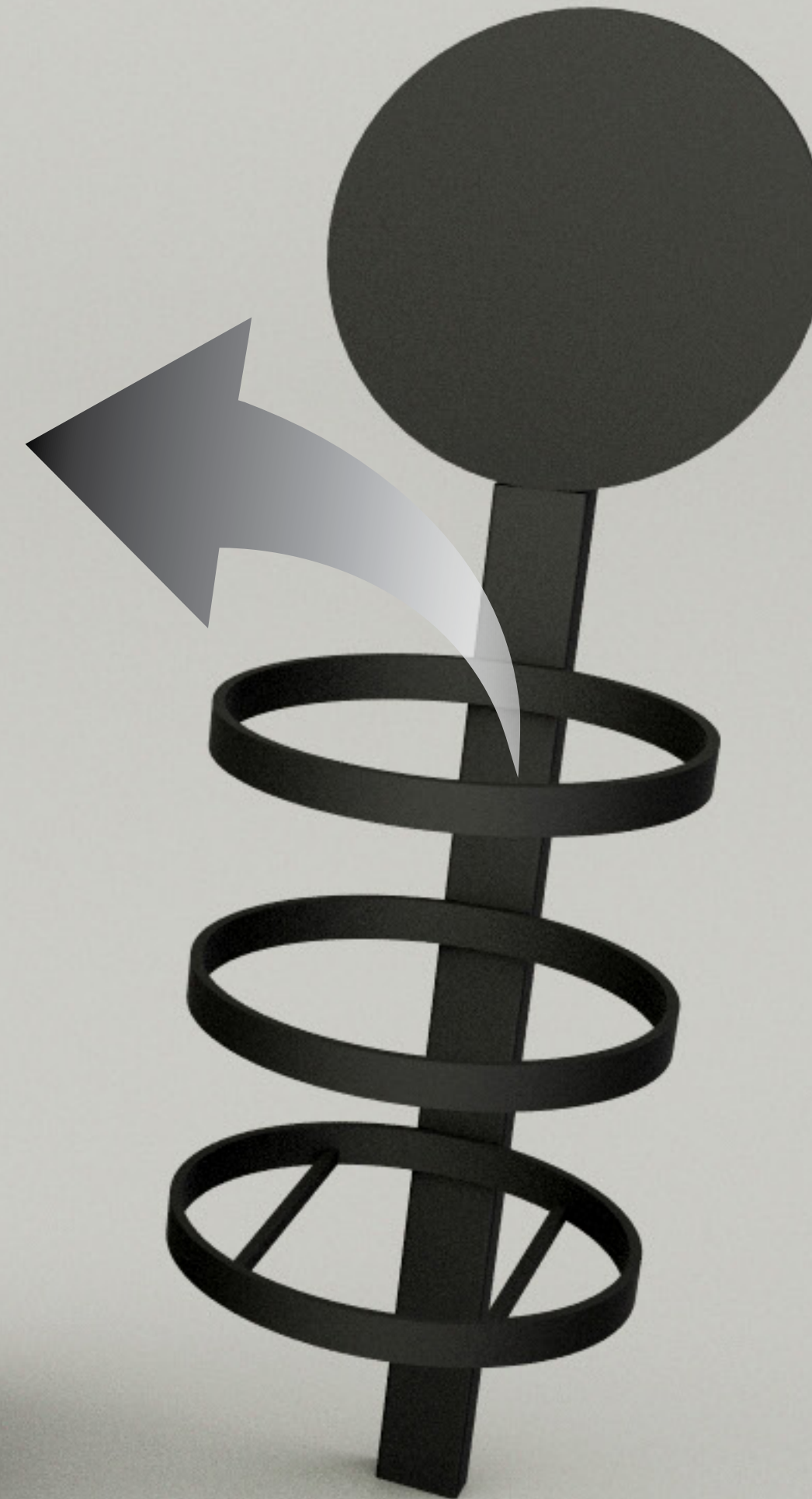

ODPADKOVÝ KÔŠ

- sietovaná nádoba na odpad

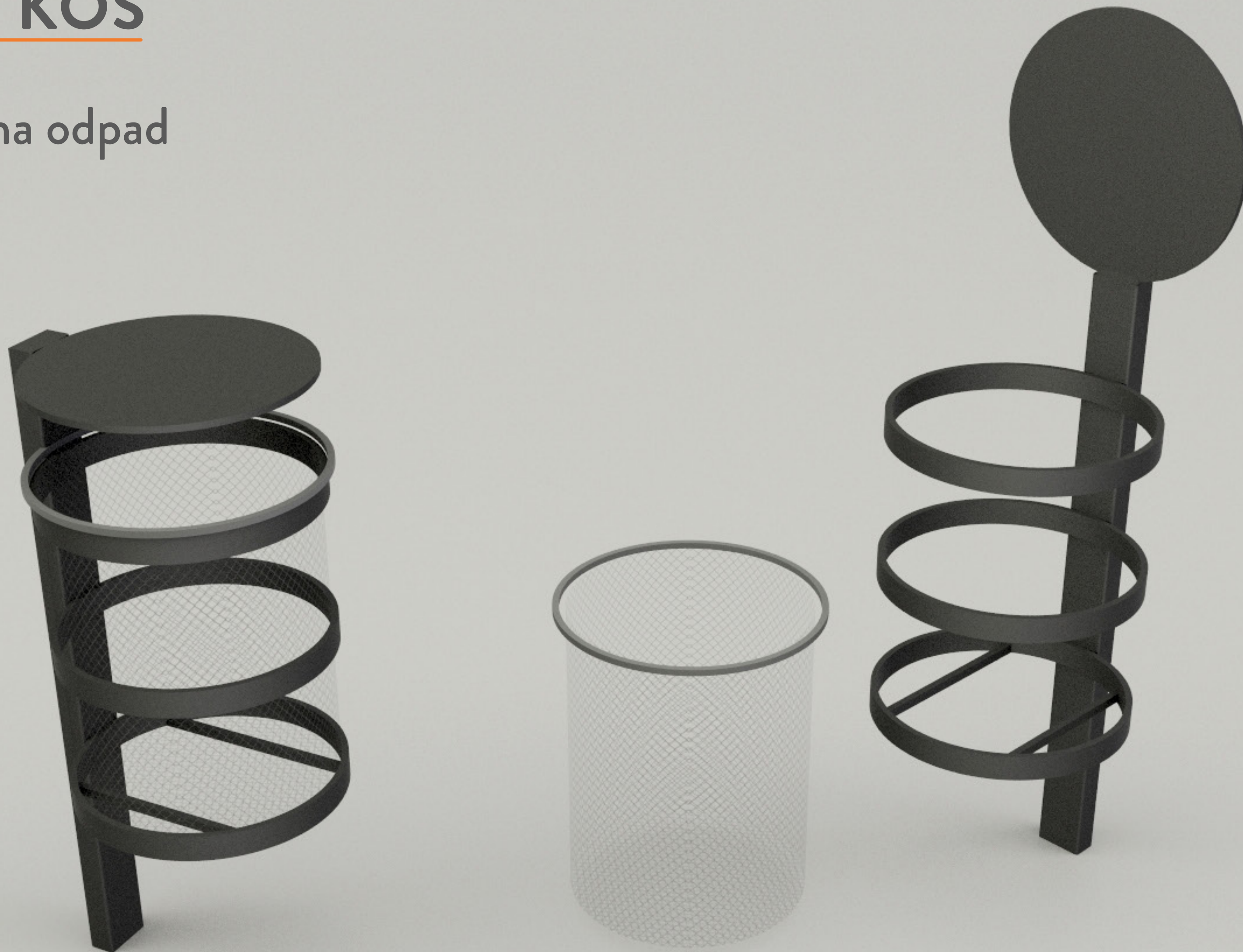

TECHNICKÉ ÚDAJE

bočný pohľad:



čelný pohľad:

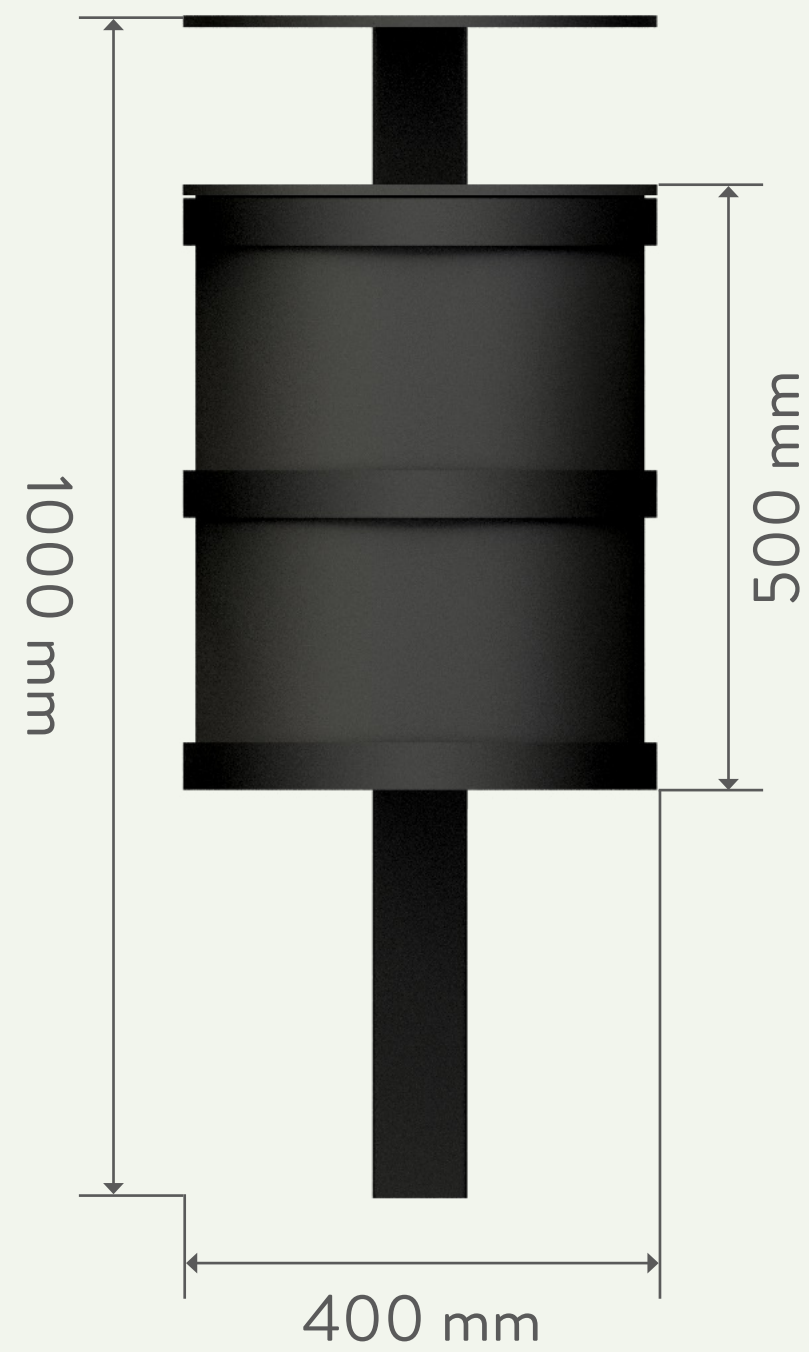

čelný pohľad:
(bez zbernej nádoby)

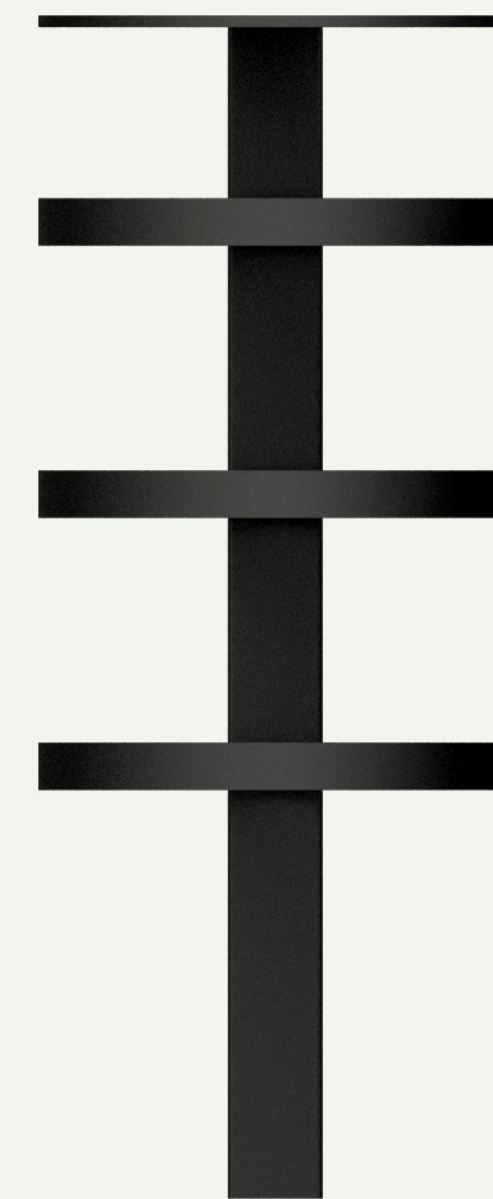

vrchný pohľad:

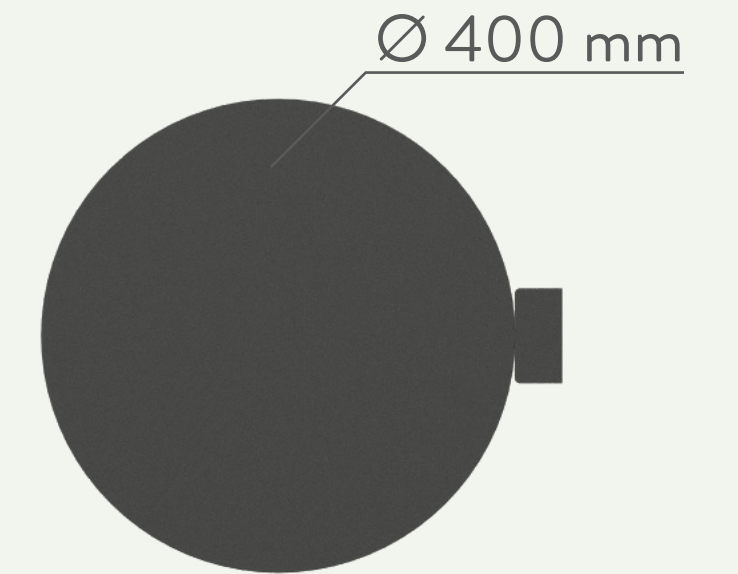

spodný pohľad:

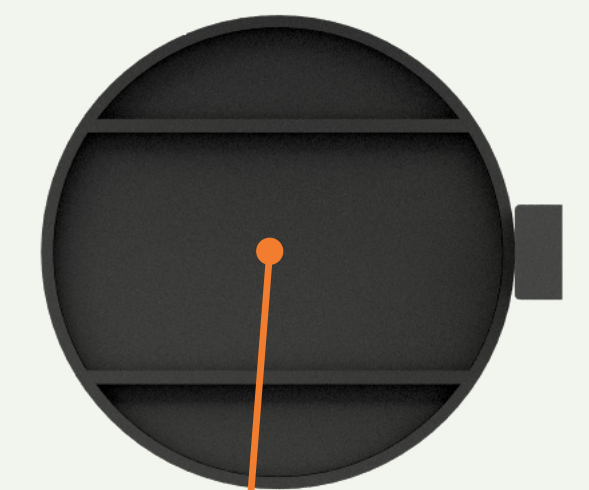

detail podporných profilov

DETAIL VYKLÁPANIA

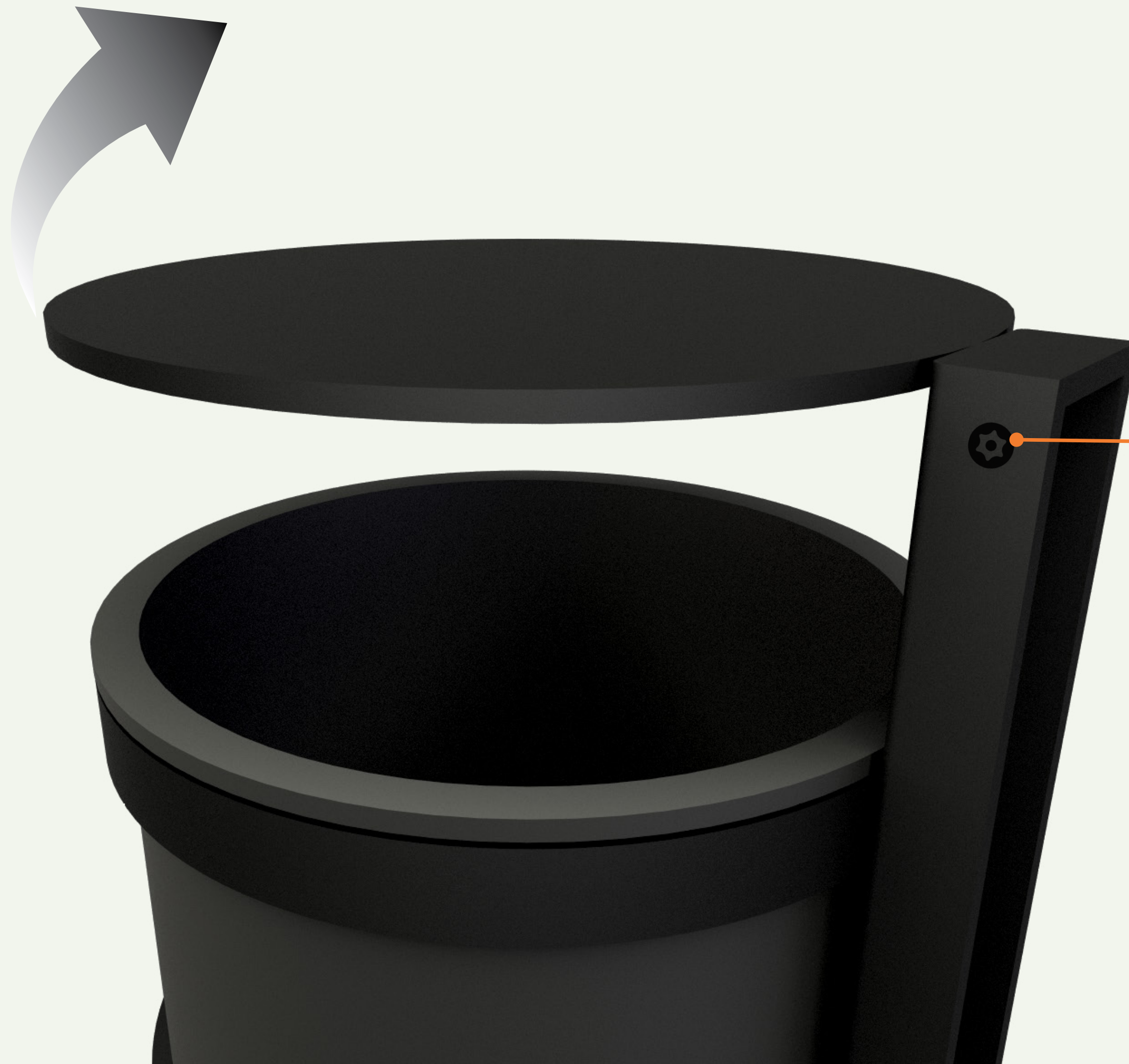

• skrutka s hlavou TORX

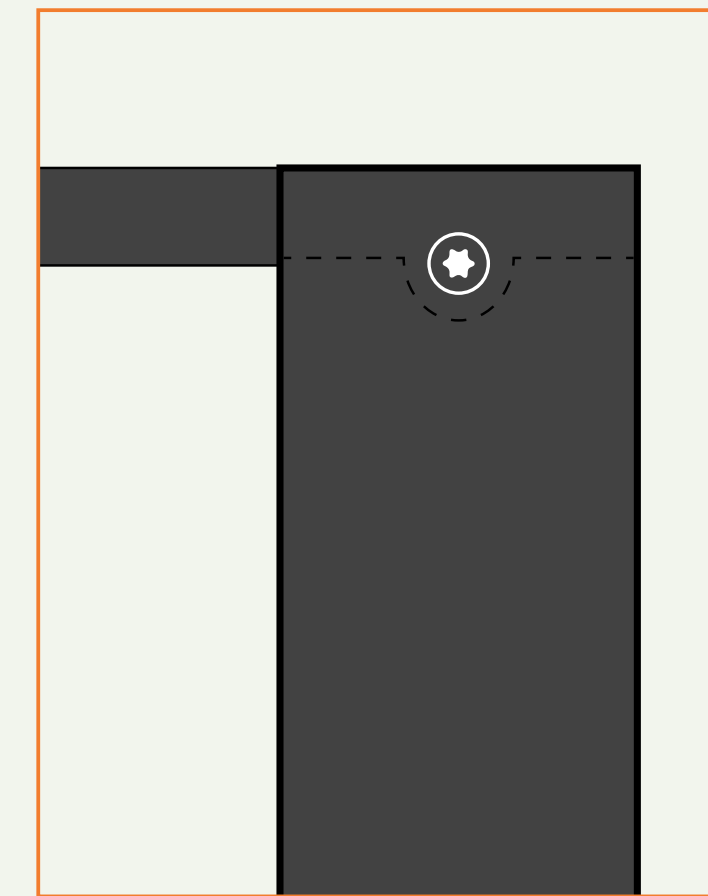

1.

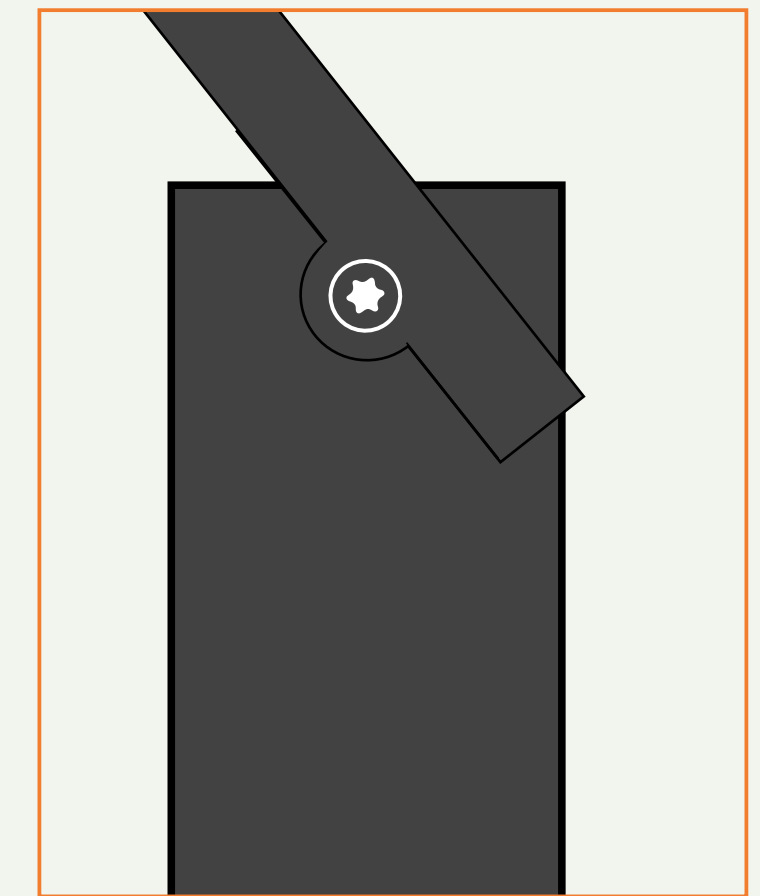

2.

ODPADKOVÝ KÔŠ – ALTERNATÍVA



ODPADKOVÝ KÔŠ – ALTERNATÍVA

- ukážka vytiahnutej nádoby na odpad
- objem 40 l



STOJAN NA BICYKEL



STOJAN NA BICYKEL



TECHNICKÉ ROZMERY

čelný pohľad:

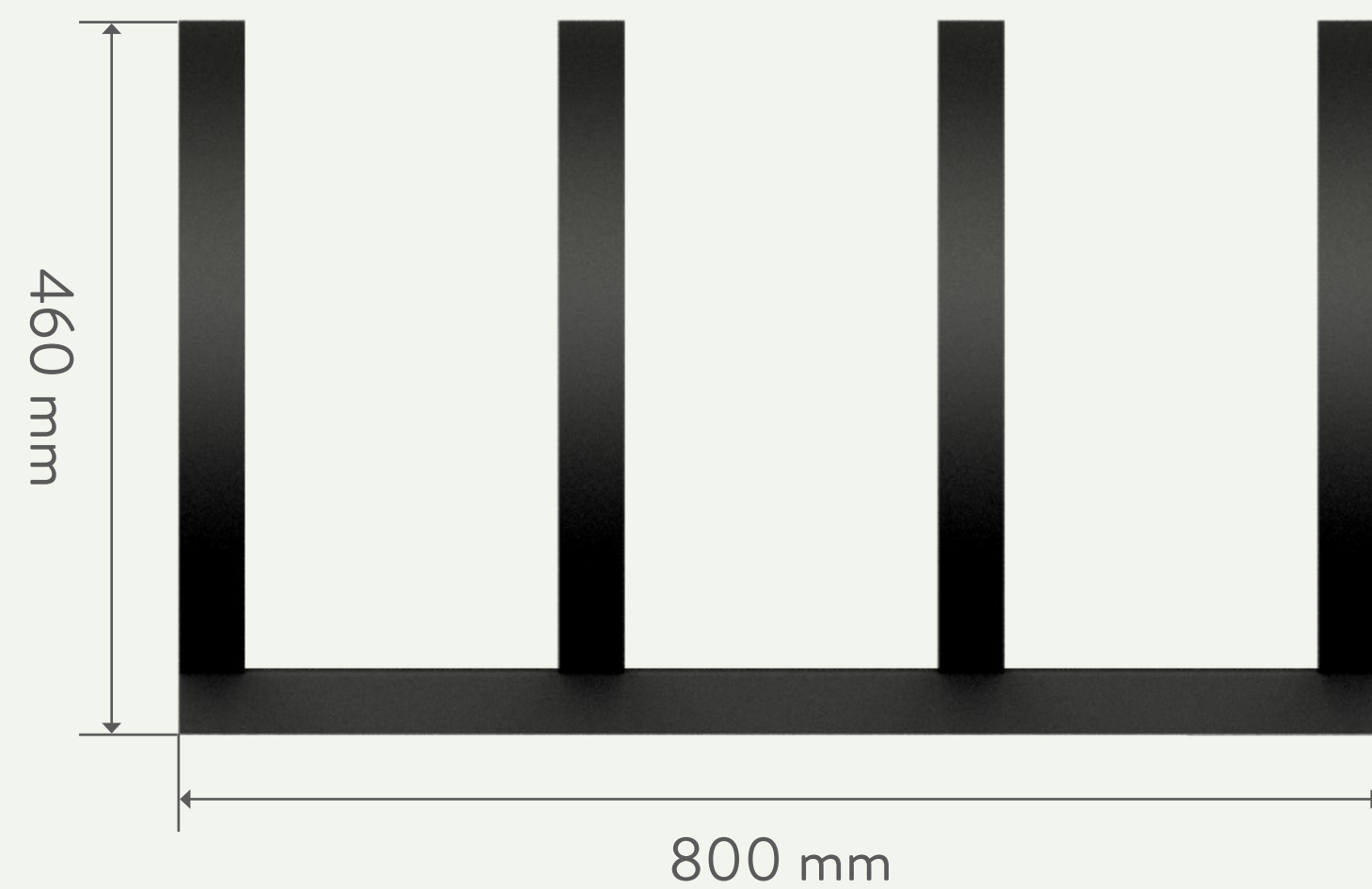

bočný pohľad:

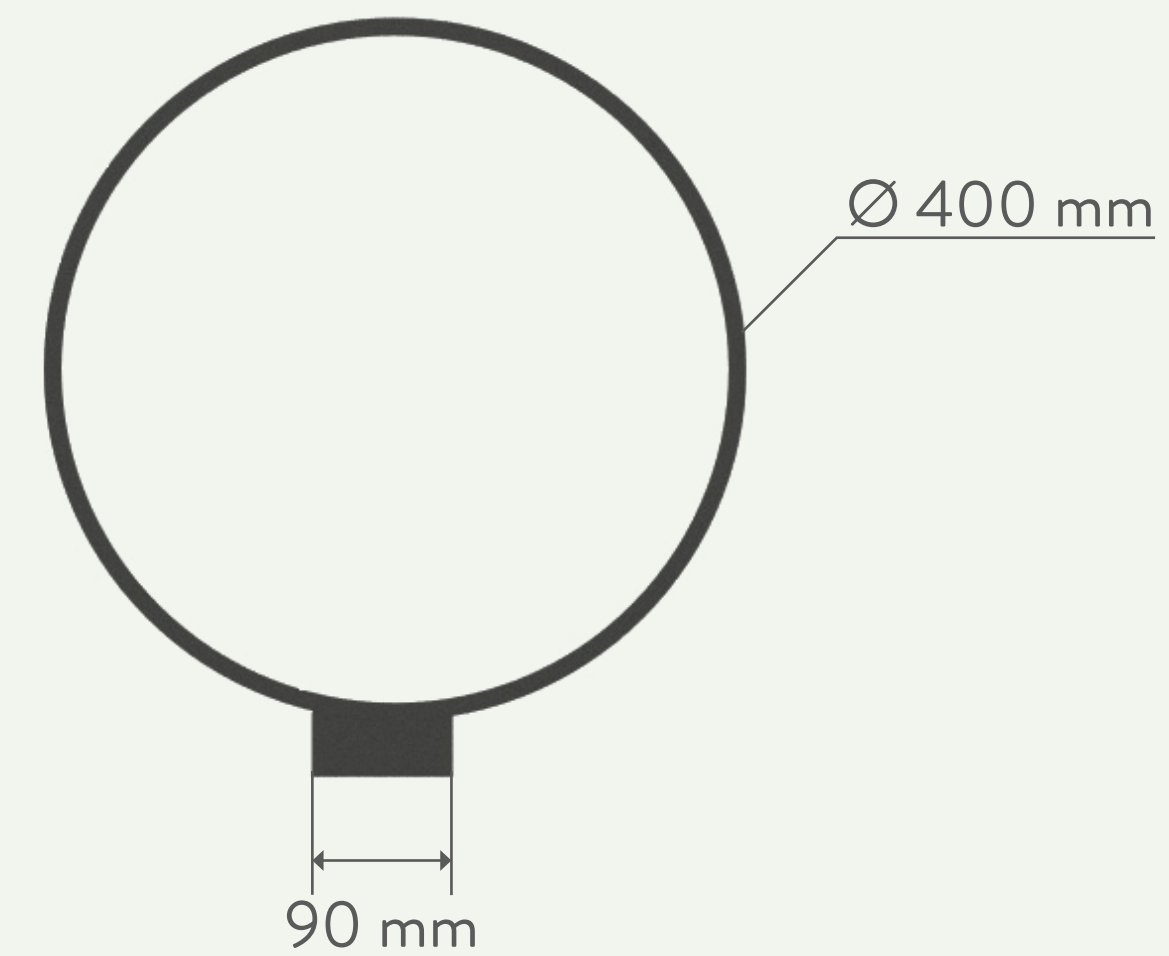

vrchný pohľad:

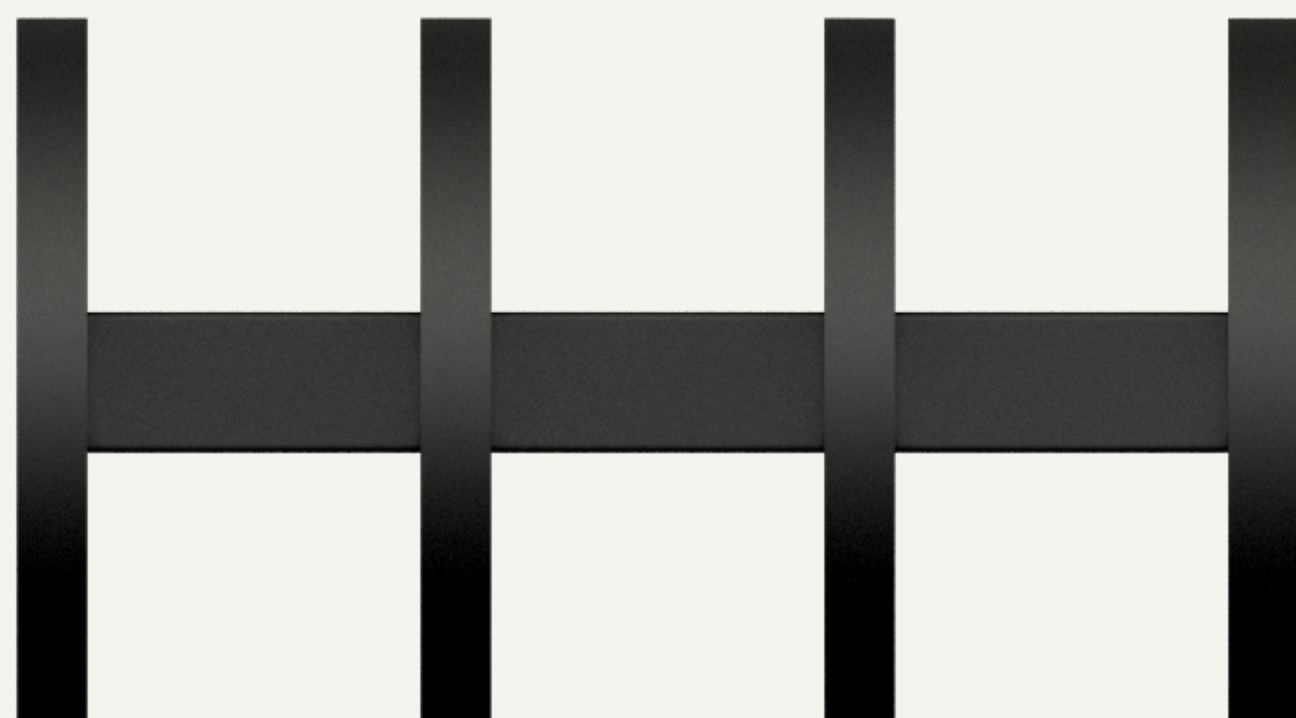

- schéma kotvenia

STOJAN NA BICYKEL

- rozšírené varianty stojanov

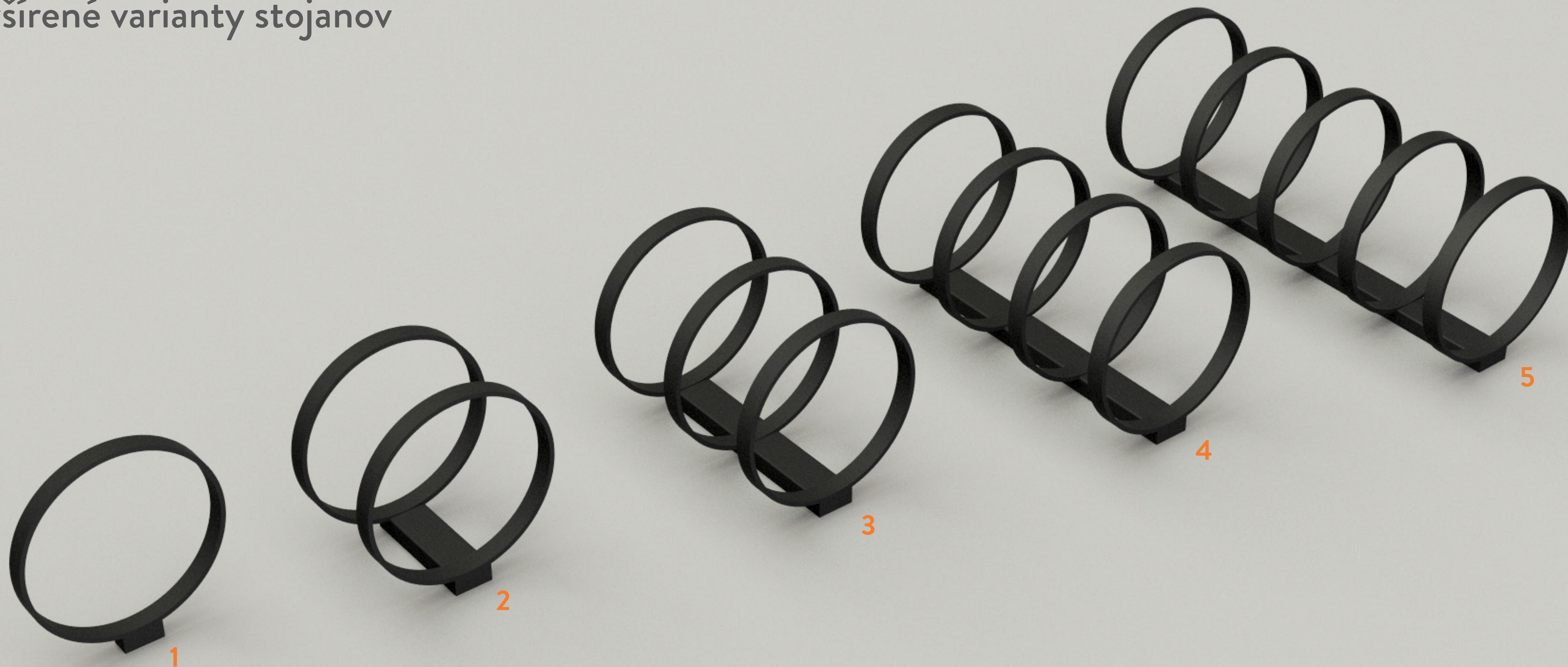

STOJAN NA BICYKEL

- preferované varianty stojanov

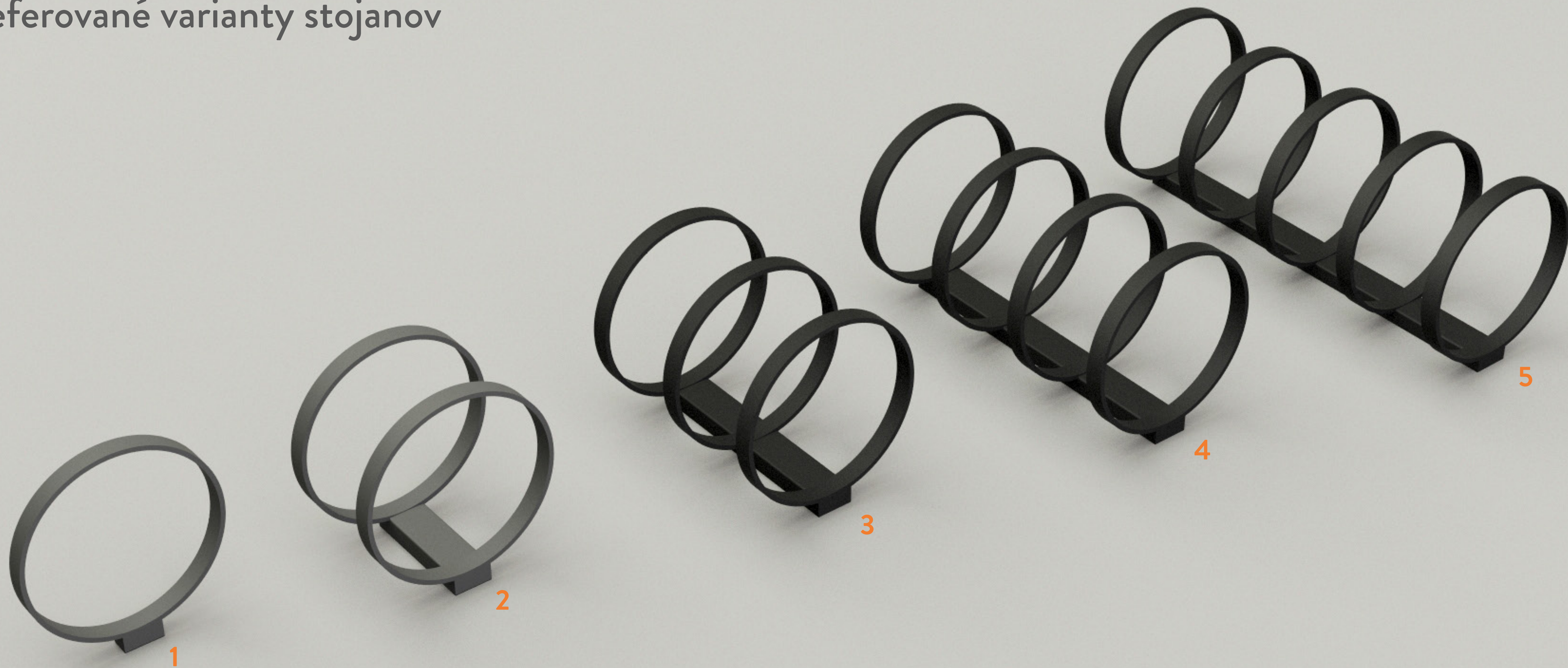

STOJAN NA BICYKEL – ALTERNATÍVA



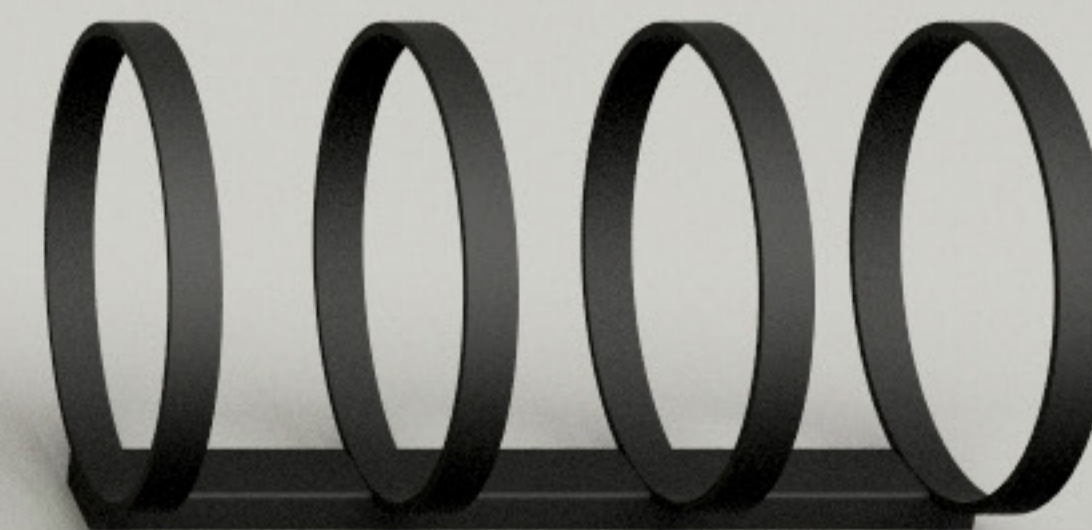

ĎAKUJEM ZA POZORNOST