

/ Alexandra Kuncová
2.ročník
AVK

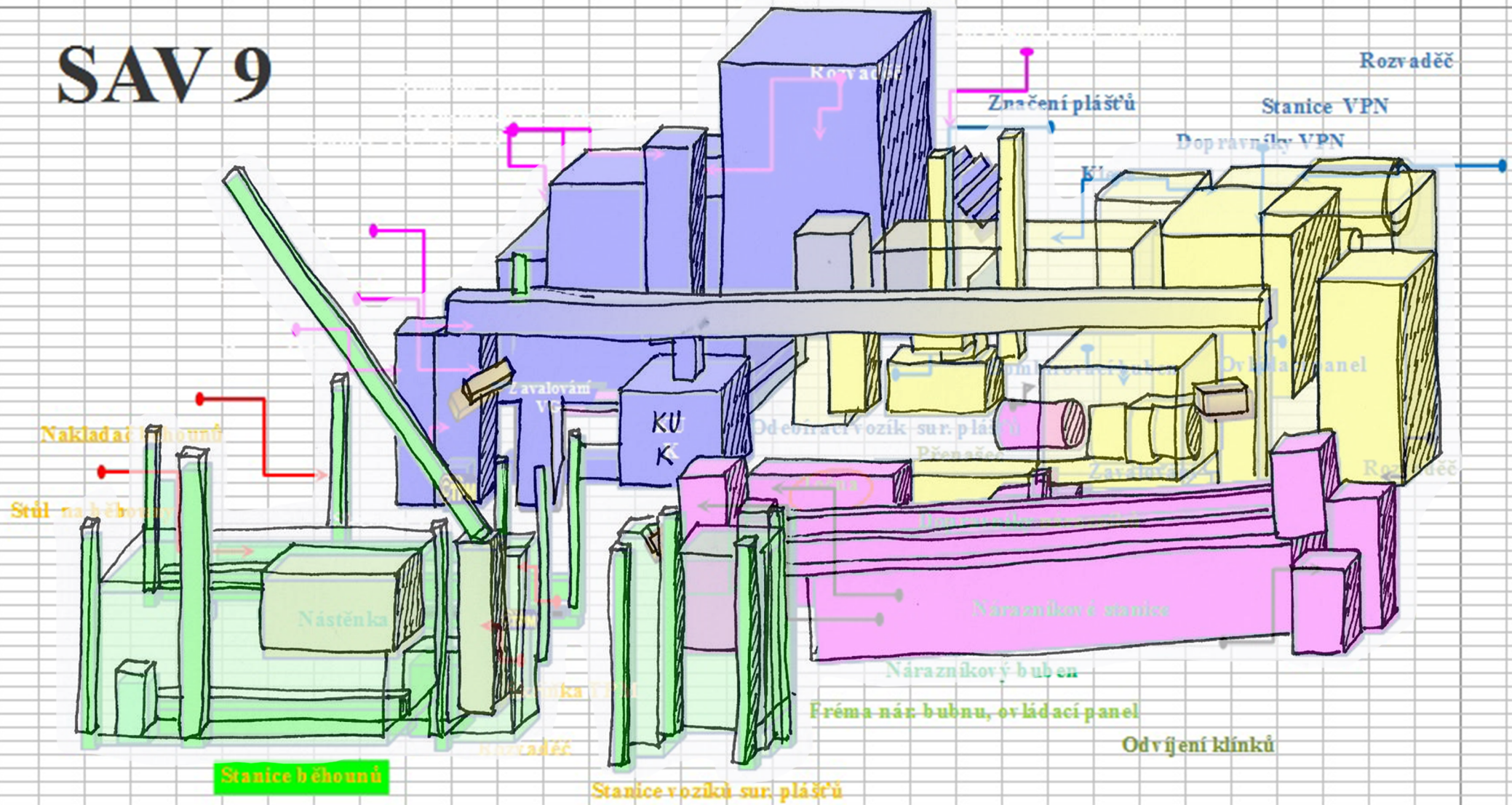

našou úlohou bolo vytvoriť informačné tabule
so schémami konfekčných strojov
do výrobnnej haly

SAV 9



/ ako som postupovala

KONFEKCE CVT - LAYOUT

Ing. M. A. KOVÁČEK
(PROKLADY Z ENAMU)

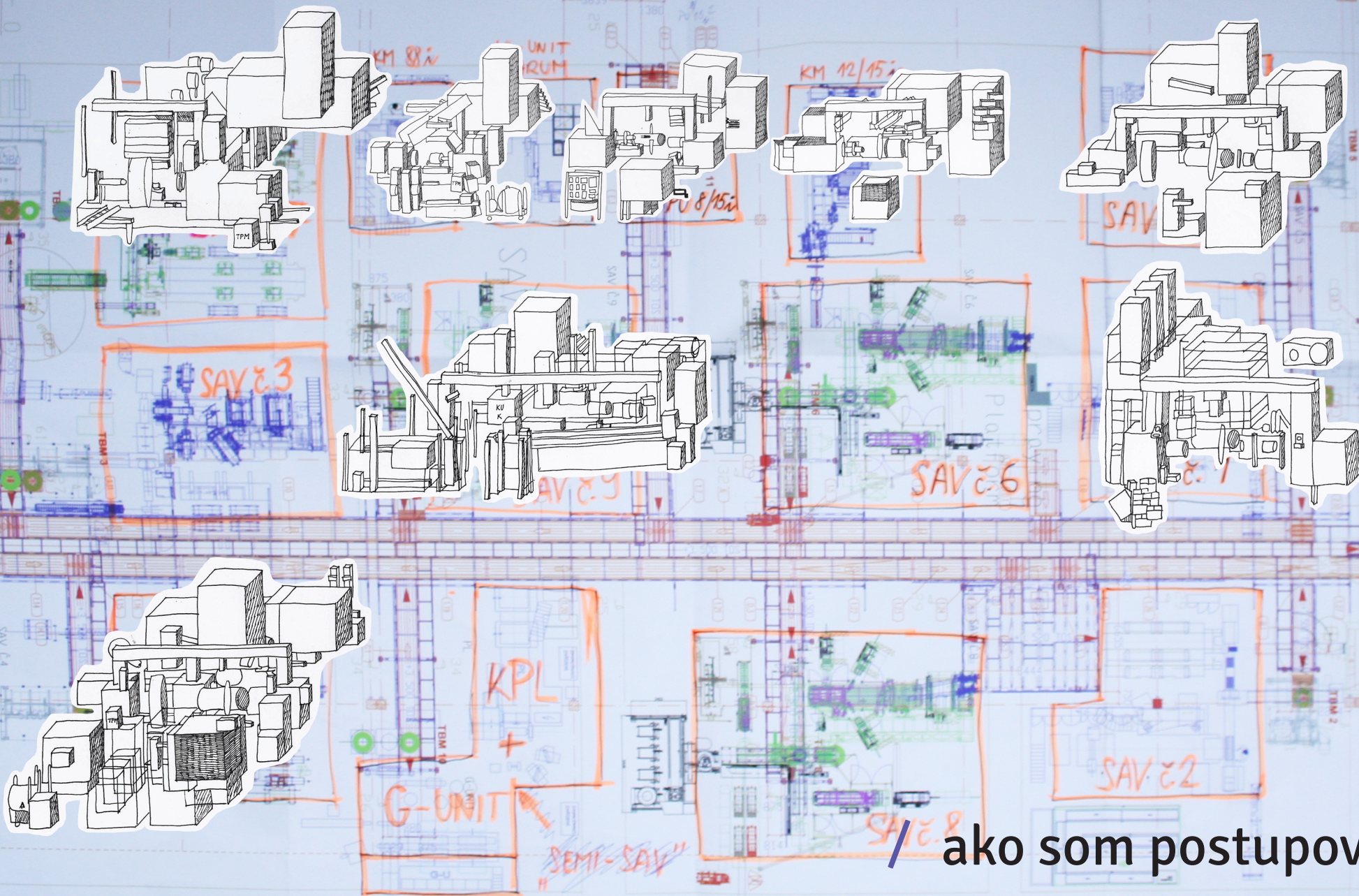

ako som postupovala

KONFEKCE CVT

53 X 89 M

KONFEKČNÝ STROJ
SAV 7

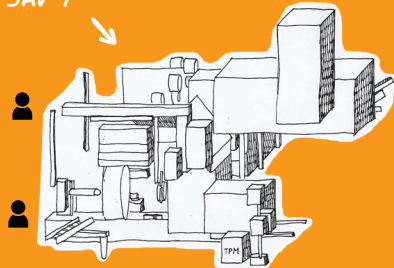

KONFEKČNÝ STROJ
K 88 I

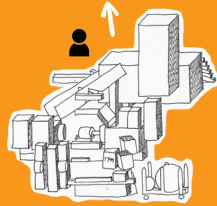

KONFEKČNÝ STROJ
K-UNIT BARUM

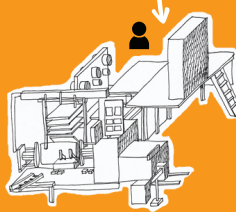

KONFEKČNÝ STROJ
PU 8/15 I

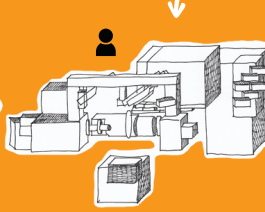

KONFEKČNÝ STROJ
KM 12/15 I

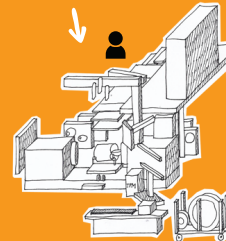

KONFEKČNÝ STROJ
SAV 5

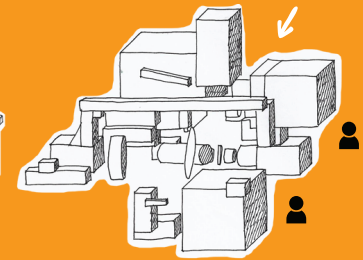

KONFEKČNÝ STROJ
SAV 3

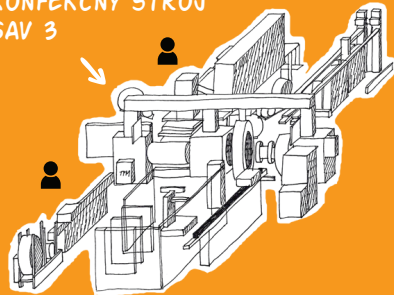

KONFEKČNÝ STROJ
SAV 9

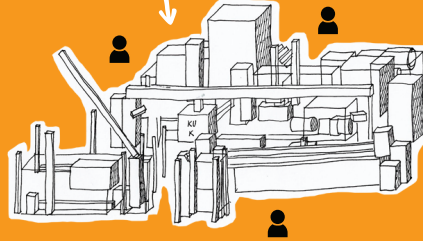

KONFEKČNÝ STROJ
SAV 6

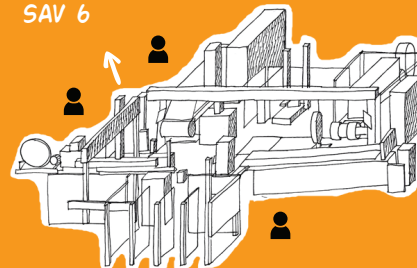

KONFEKČNÝ STROJ
SAV 1

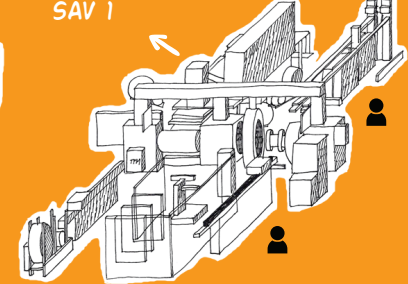

KONFEKČNÝ STROJ
SAV 4

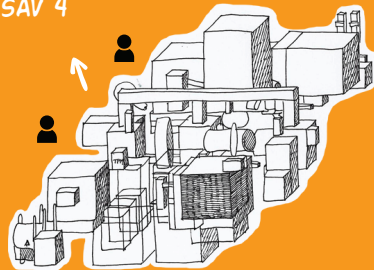

KONFEKČNÝ STROJ
PL/G

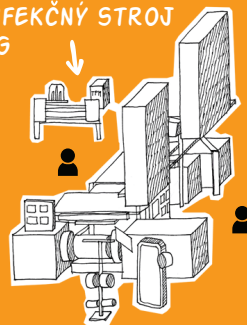

KONFEKČNÝ STROJ
SAV 8

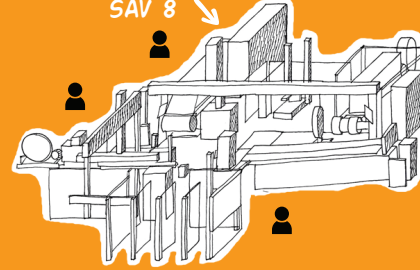

KONFEKČNÝ STROJ
SAV 2

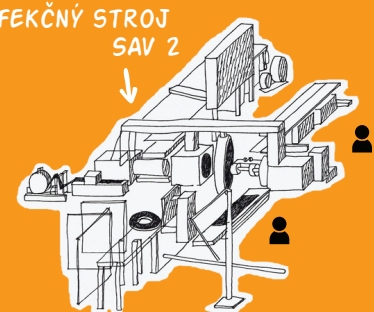

KM 88I, K-UNIT

SAV Č. 5,6,8,9

SAV Č. 1,2,3,4,7, PL/G

SAV 1, 2, 3

-17,5/20/22,5

SAV 4,7

-20/22,5/24

SAV 5,6,8,9

-17,5

PL/G

-18/20

PU 8/15I, KM 12/15I

-8/9/10/12/15/16

KM 88I, K-UNIT

-8/9/10/12/15/16

Continental

KONFEKČNÝ STROJ
SAV 3

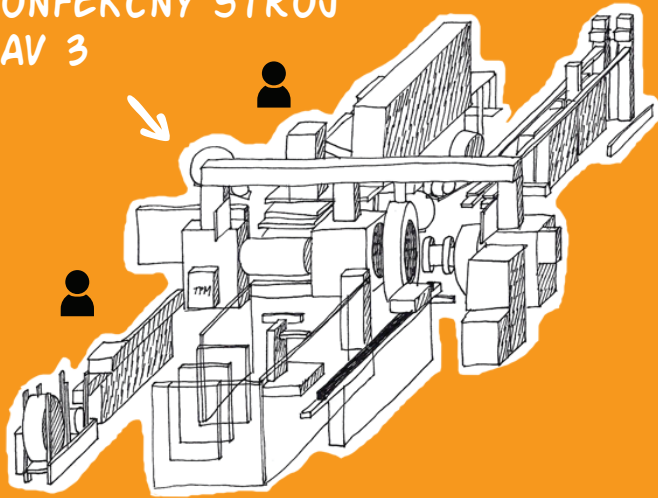

KONFEKČNÝ STROJ
SAV 9

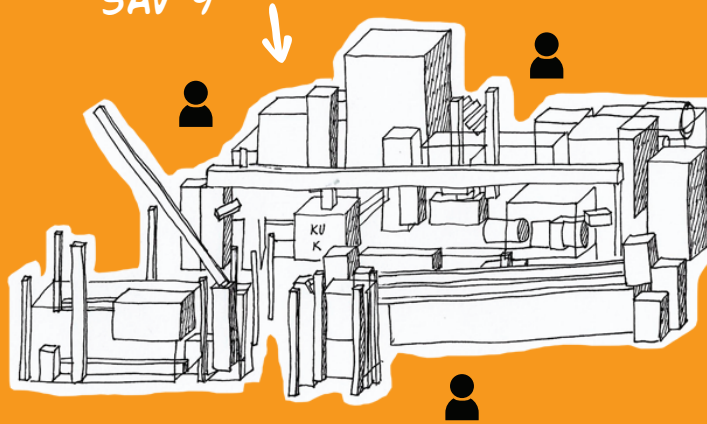

KONFEKČNÝ STROJ
SAV 6

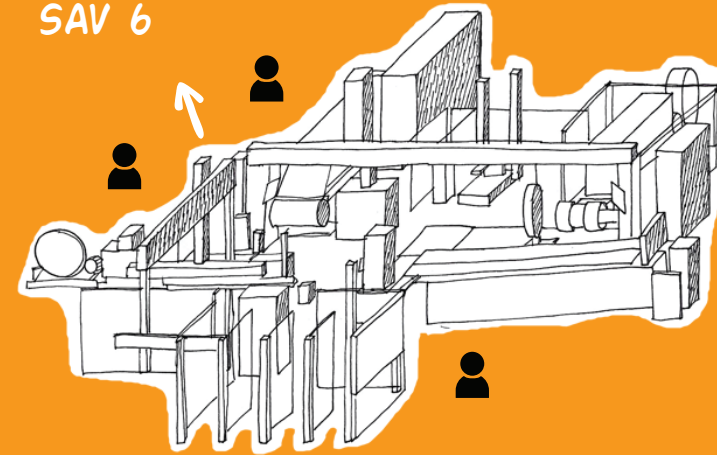

KONFEKČNÝ STROJ
SAV 4

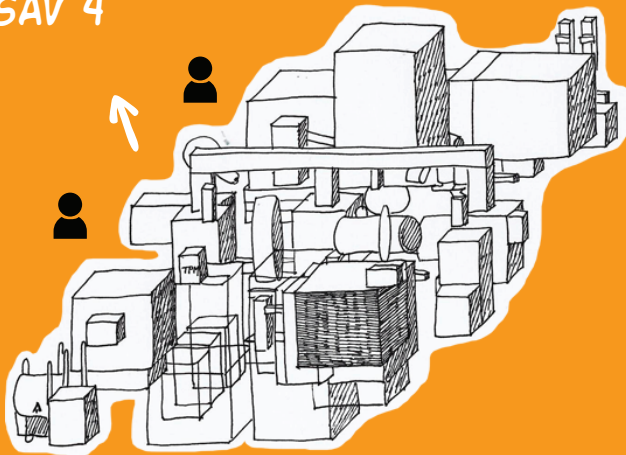

KONFEKČNÝ STROJ
PL/G

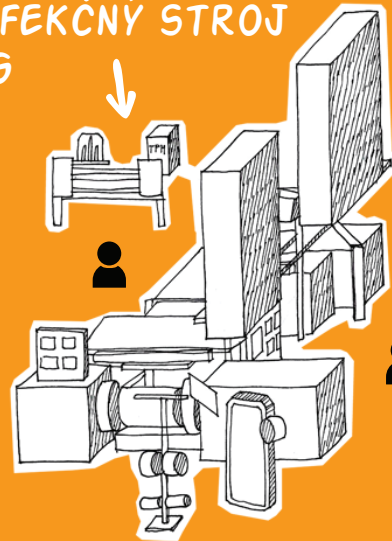

KONFEKČNÝ STROJ
SAV 8

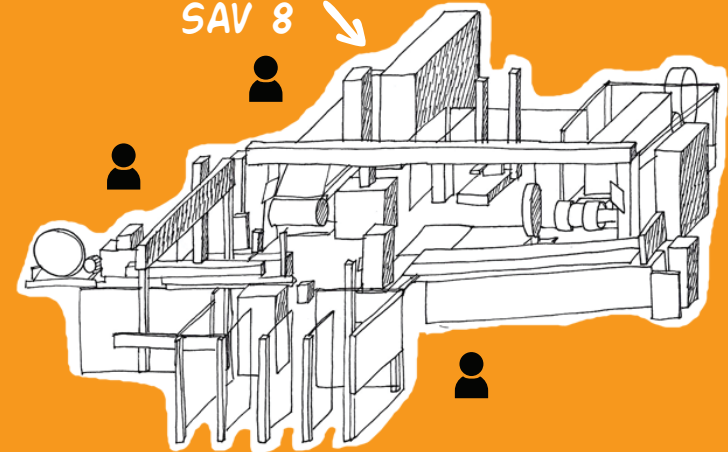

K

KM 88I, K-UNIT

SAV 1, 2, 3

SAV 4,7

SAV 5,6,8,9

PL/G

PU 8/15I, KM 12/15I

SAV Č. 5,6,8,9

-17,5/20/22,5

-20/22,5/24

-17,5

-18/20

-8/9/10/12/15/16

SAV Č .1,2,3,4,7, PL/G

DOKONČOVNA CVT

36 X 90 M

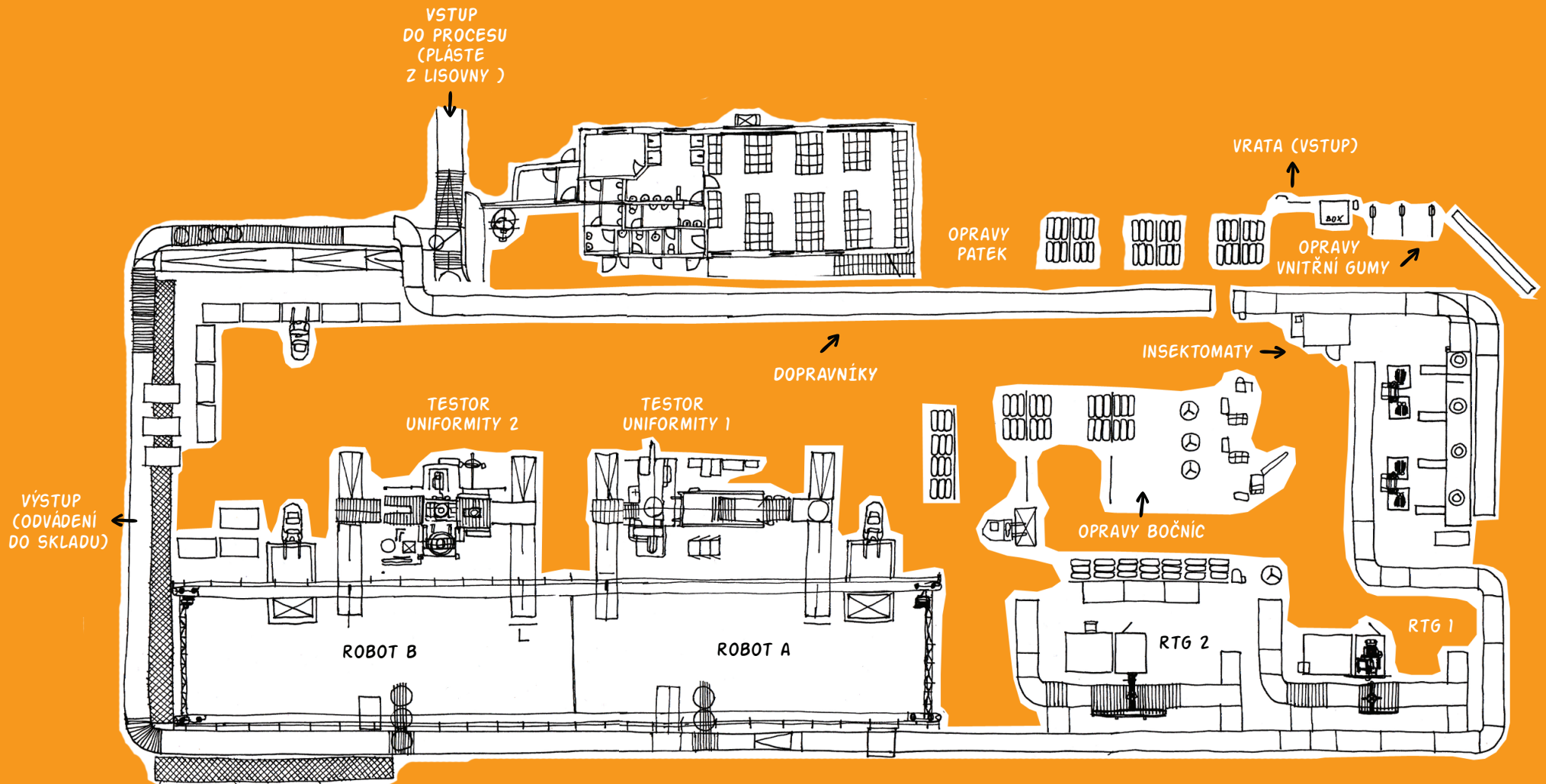

GRACER, OPRAVY VNITŘNÍ GUMY, OPRAVY PATEK



INSPEKTOMATY

DOKONČOVNA CVT

36 X 90 M

VSTUP
DO PROCESU
(PLÁSTE
Z LISOVNY)

VRATA (VSTUP)

OPRAVY
PATEK

OPRAVY
VNITŘNÍ GUM

DOPRAVNÍKY

INSEKTOMATY

TESTOR
UNIFORMITY 2

TESTOR
UNIFORMITY 1

OPRAVY BOČNIC

ROBOT B

ROBOT A

RTG 2

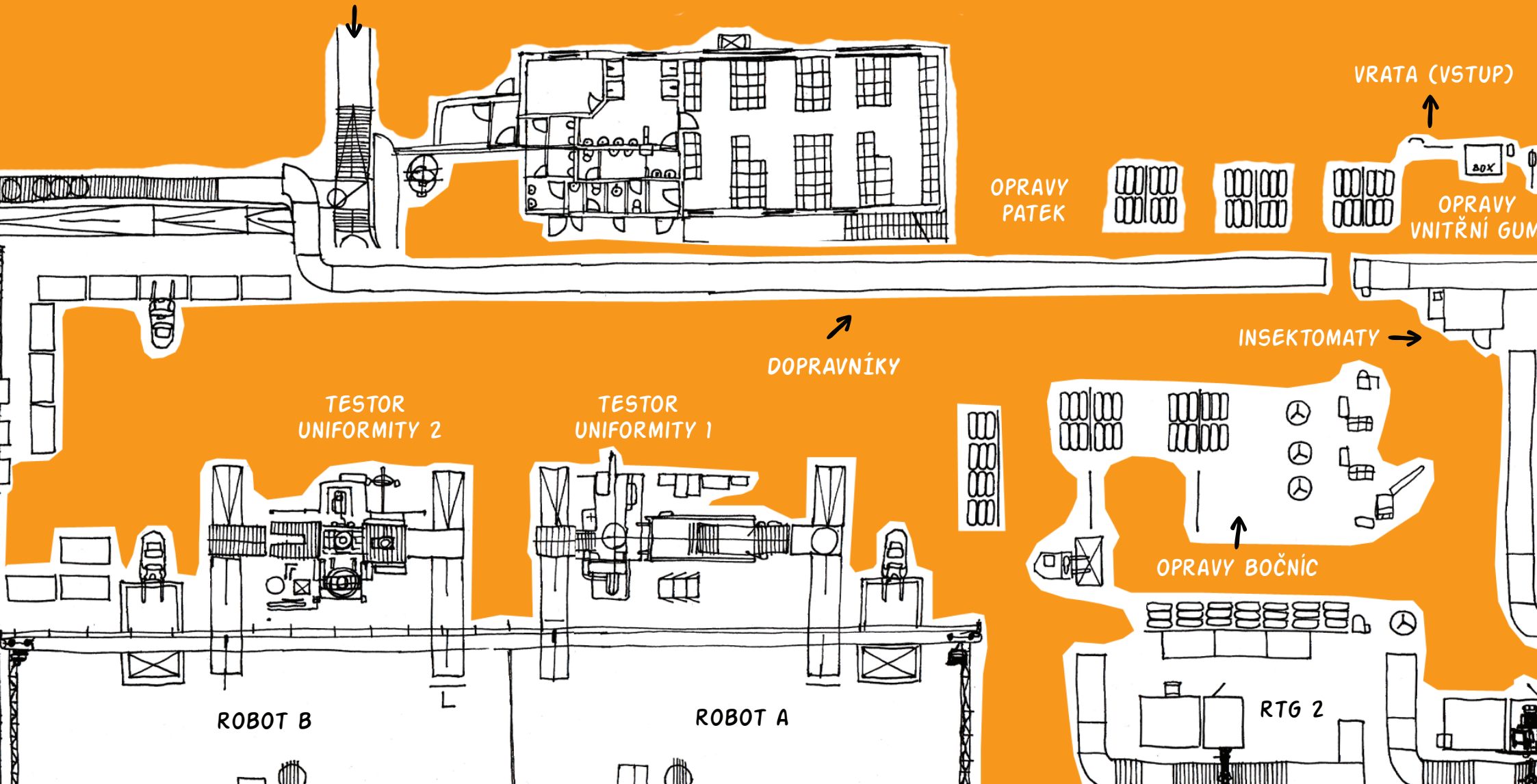

/ Ďakujem za pozornosť !